



**MeiLoon Industrial Co., Ltd.**

**2021**

**Investor Conference**

# Meeting Outline

- ◆ **Company Introduction**      General Manager– Vincent Lin
- ◆ **Company Management**      Director of R&D and Sales – Michael Wu
- ◆ **Q&A**

# Disclaimer

**MeiLoon's presentation contains forward-looking statements subject to uncertainties. Actual results may differ from those contained in the forward-looking statements.**

**The forward-looking statements in this release reflect the current belief of MeiLoon as of the date of this release, we undertake no obligation to update these forward-looking statements for new information ,future events, or otherwise.**

The logo for MeiLoon features the word "MeiLoon" in a stylized, blue, 3D font. The letter "i" is lowercase and has a red dot. The "L" is uppercase and has a red dot. The "o" is lowercase and has a red dot. The "n" is lowercase and has a red dot. The background of the logo is a light blue gradient with a globe and glowing lines.

**MeiLoon**

Quality • Innovation • Performance • Partnership

# Company Introduction

◆ **Main Milestones**

◆ **Worldwide Presence**



# Main Milestones



- 1973 Factory founded in Taipei
- 1983 Taipei Office founded
- 1993 Dongguan Meiloon established
- 1995 U.S.A. Office established
- 1996 ISO-9001 certificated
- 1997 ISO-14001 certificated
- 1998 U.K. Office established
- 2000 Meiloon went IPO in Taiwan (Initial Public Offer)
- 2002 QS 9000 Certificated
- 2004 Meida Technology (Suzhou) established
- 2009 DG factory TS 16949 certificated
- 2011 DG factory Global Security Verification
- 2013 SZ factory TS 16949 certificated
- 2014 Introduces First Play-Fi™ wireless audio speaker
- 2018 DG factory IATF 16949 certificated
- 2019 DG factory QC080000 certificated
- 2020 Taiwan Automation Factory established
- 2020 Taiwan ISO 9001 Certificated
- 2021 Indonesian Factory established

# Worldwide Presence



Taiwan :  
Meiloon Industrial Co., Ltd.



China:.  
Dongguan Meisin Audio Equipment Co., Ltd.  
Dongguan Meiloon Industrial Co., Ltd



Indonesia :  
PT. Meiloon Technology Indonesia  
(Indonesia Factory established in 2021)



# Indonesia Factory

The construction of the new facility will be finished in 2021 and operation in 2022.

## Rebana Golden Triangle – New Industrial Area and Town Development

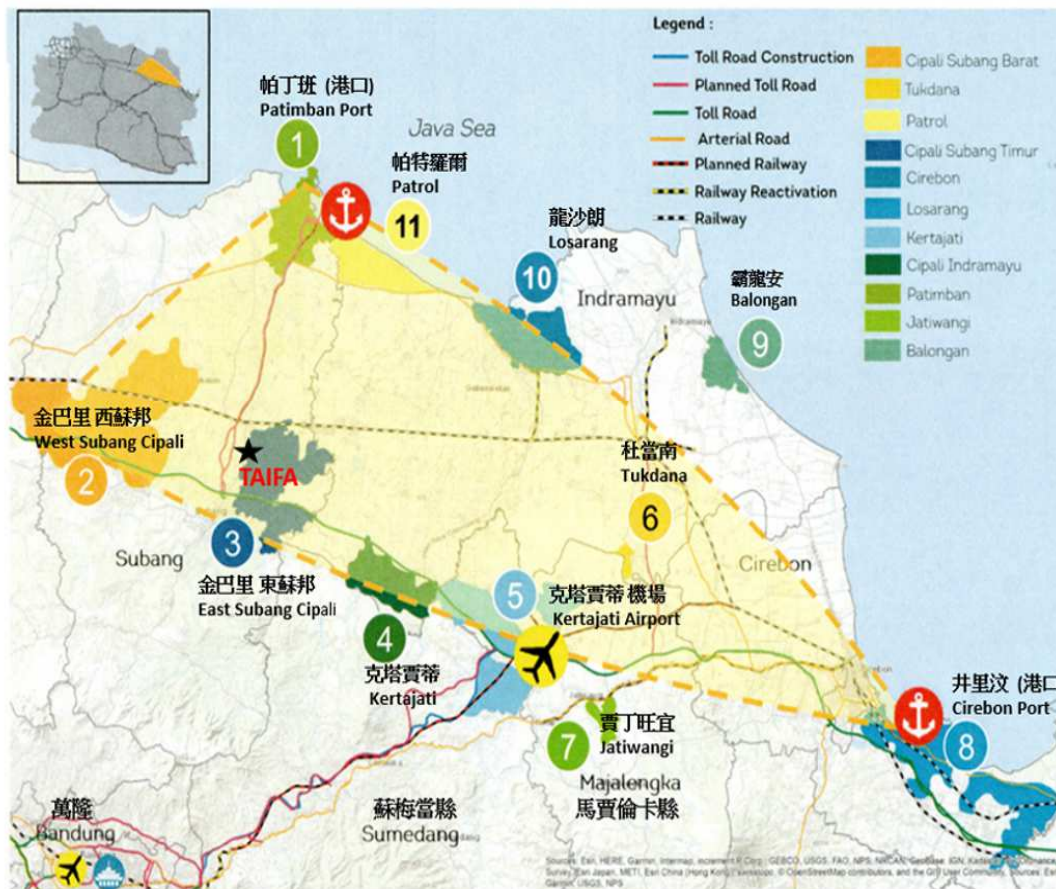

台發工業區位於政府新經濟開發政策的 Rebana 黃金三角正核心。

TAIFA Industrial Park is located at the core of the Rebana Golden Triangle of the Government's new economic development policy.

位居陸海空交通樞紐；連外道路15米餘寬；距高速公路出入口及東西橫貫鐵路僅5公里。

TAIFA is located at the Land · Sea and Air Transportation Junction. Its access road is more than 15 meters wide and it is only 5 KM away from the interchange of the Expressway and the East-West Railway Station.

新建機場及港口預計YR 2023完工，離園區僅50公里內。

The new airport and port are expected to be completed by YR 2023 and they are within 50KM from TAIFA Industrial Park.

# The Revenue Contribution of World-Wide Factories

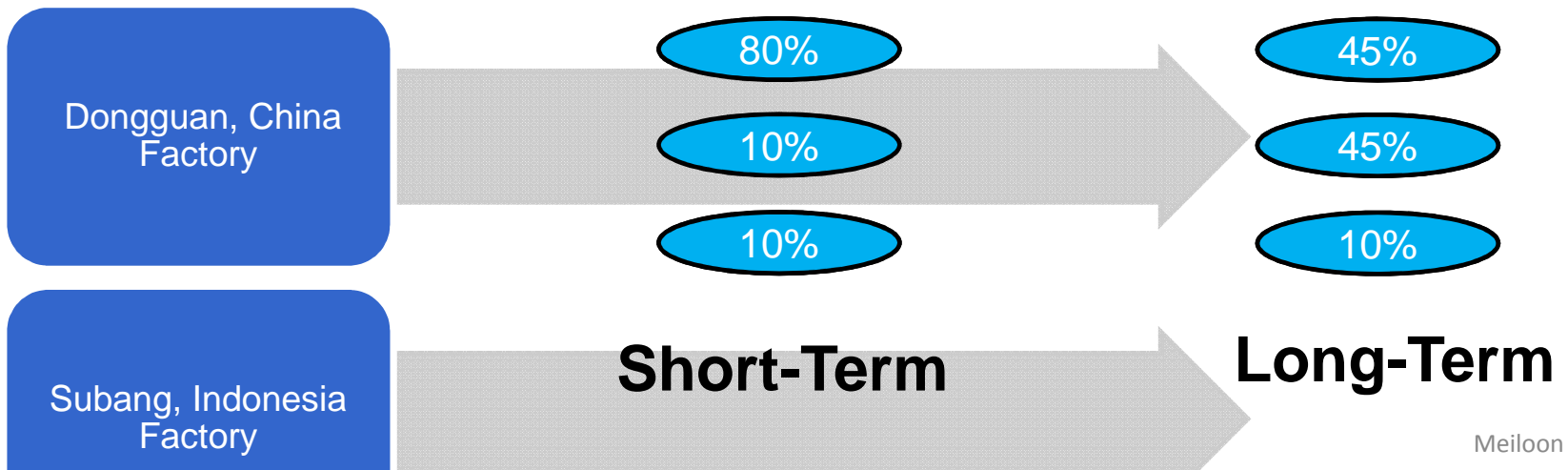
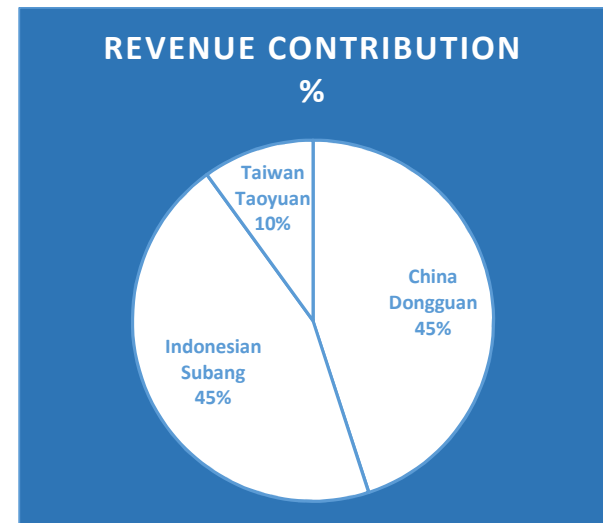
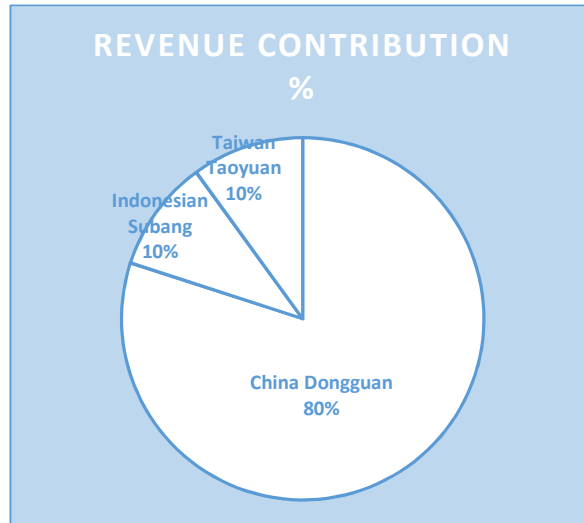

## ◆ Business Performance



# Business Performance

## Y2015-Y2021 REVENUE (M NTD)

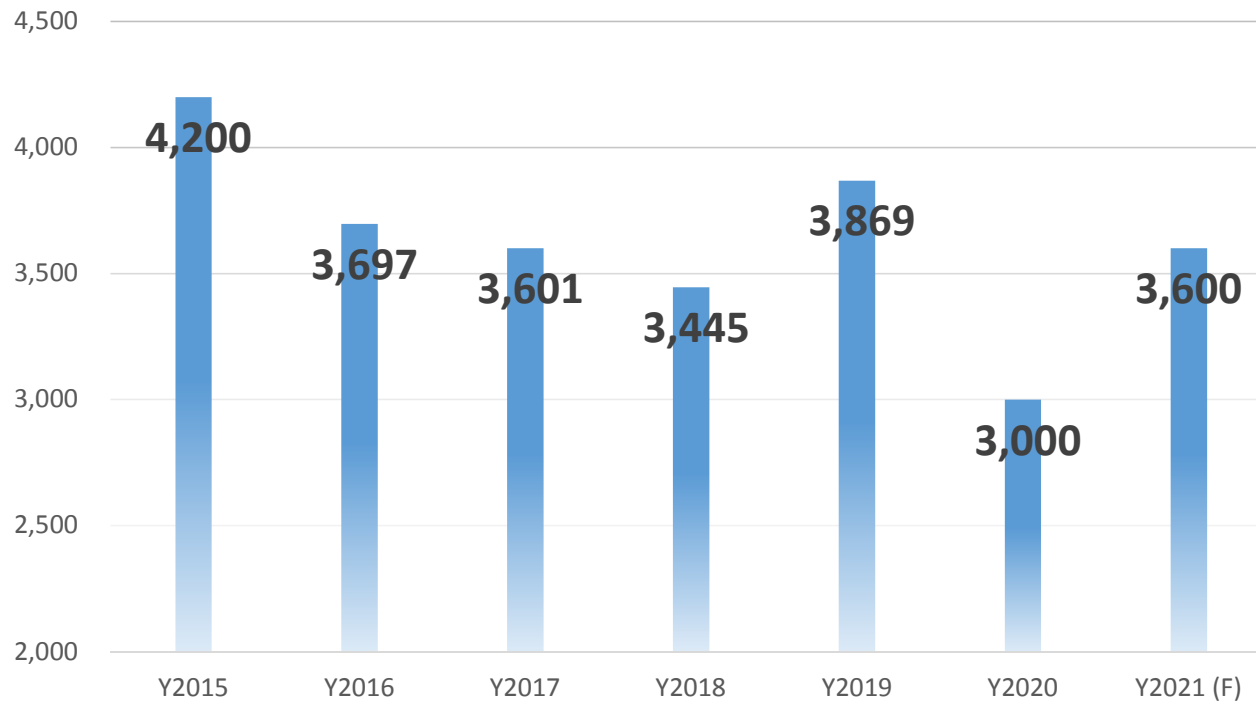

**In 2021, the business will return to the level before the Covid-19 epidemic :**

- 1. Adjust the customer bases%, categories and regions**
- 2. Ride on the Home Economy Trend**
- 3. Enhance the operation efficiency**

# Consistent to Strengthen Key Acoustic Market

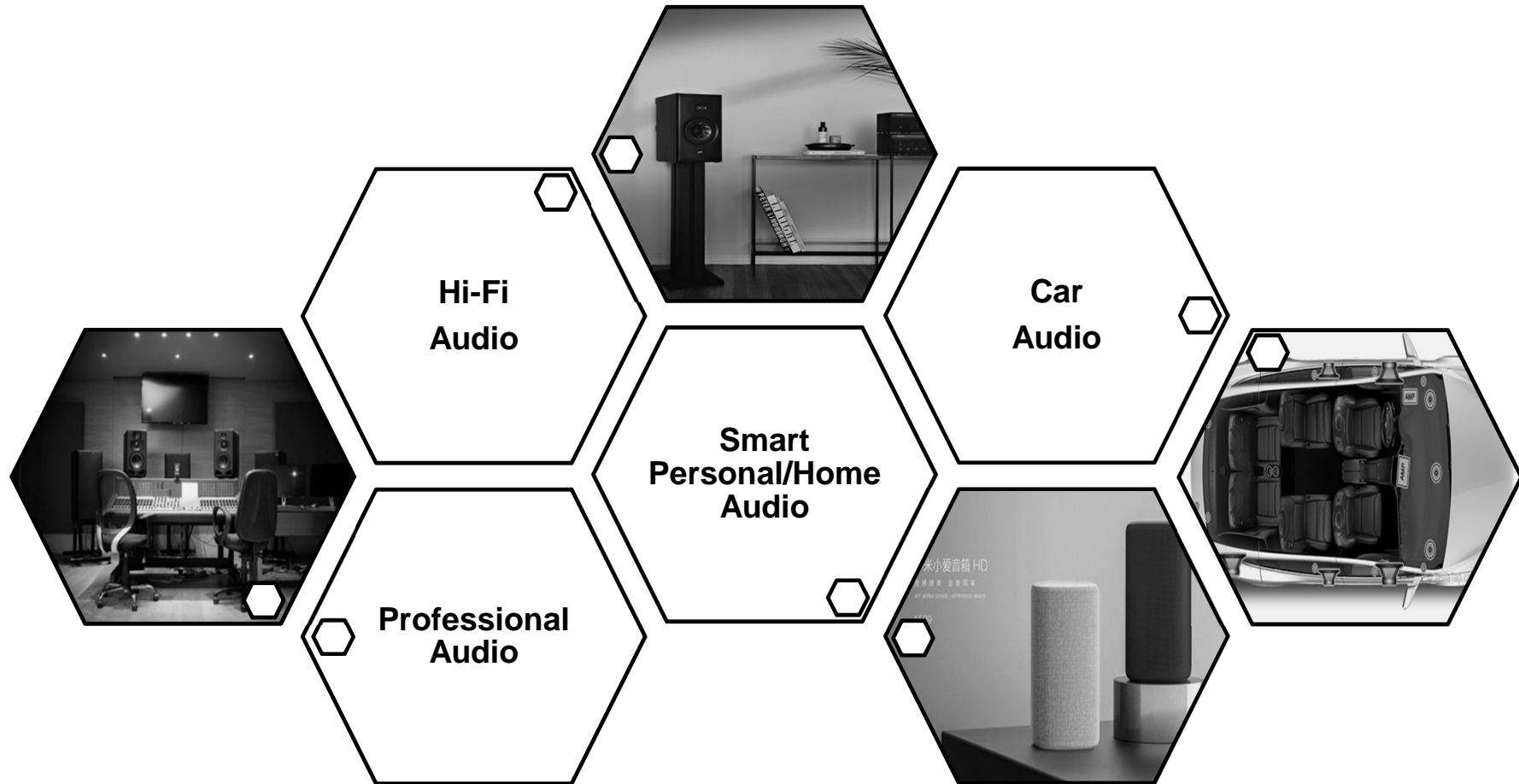

# The Targeted Rate of Sales Area & Product Category

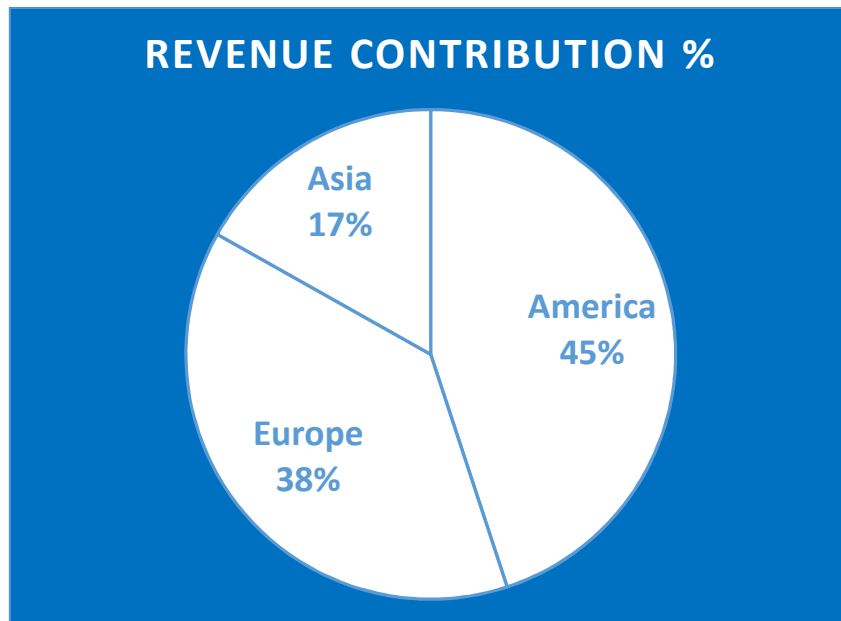

Regions	America	Europe	Asia
Hi-Fi Audio	●	●	
Car Audio	●		●
Personal/Home Audio	●	●	●
Professional Audio	●	●	

● Main Sales Area

## ◆ Products & Technology

# RESERVE SERIES

Derived from high-quality wines that have been stored for longer periods of time. making it easier to build a complete home theater.

# Polk Reserve



# Reserve Series



**The Pinnacle Ring Radiator Tweeter's** distinctive pointed shape guides the dispersion of high frequency sounds around a room. This innovation widens the sweet spot and allows you freedom to enjoy your music and movies wherever you choose to sit.



**The Polk X-Port** is a set of closed-pipe absorbers that are tuned to the internal frequency of the cabinet. This cancels out traditional resonances and distortions that you may get in the speaker's construction.

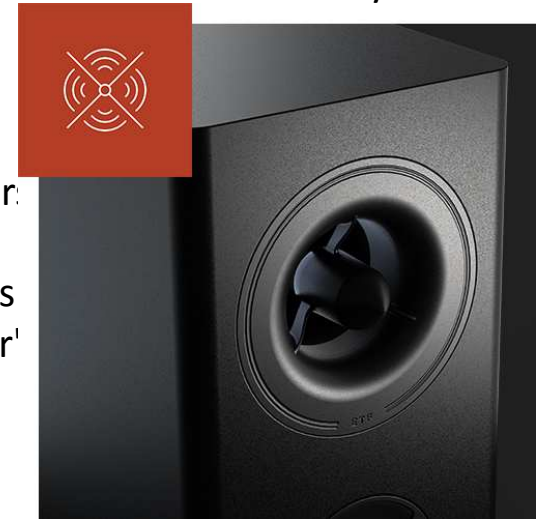

**Turbine** Our pioneering turbine design delivers a significant increase in cone rigidity without increasing mass. This innovation means the woofer can move with increased accuracy and speed to deliver enhanced sound resolution, enabling you to experience a breathtaking level of detail in your music and movies.

# Reserve Series



## Power Port 2.0

The latest version of our successful Power Port Technology combines a carefully engineered port design with the new patent pending X-Port.

With these combined, you get smooth, effortless, distortion free bass without any chuffing.

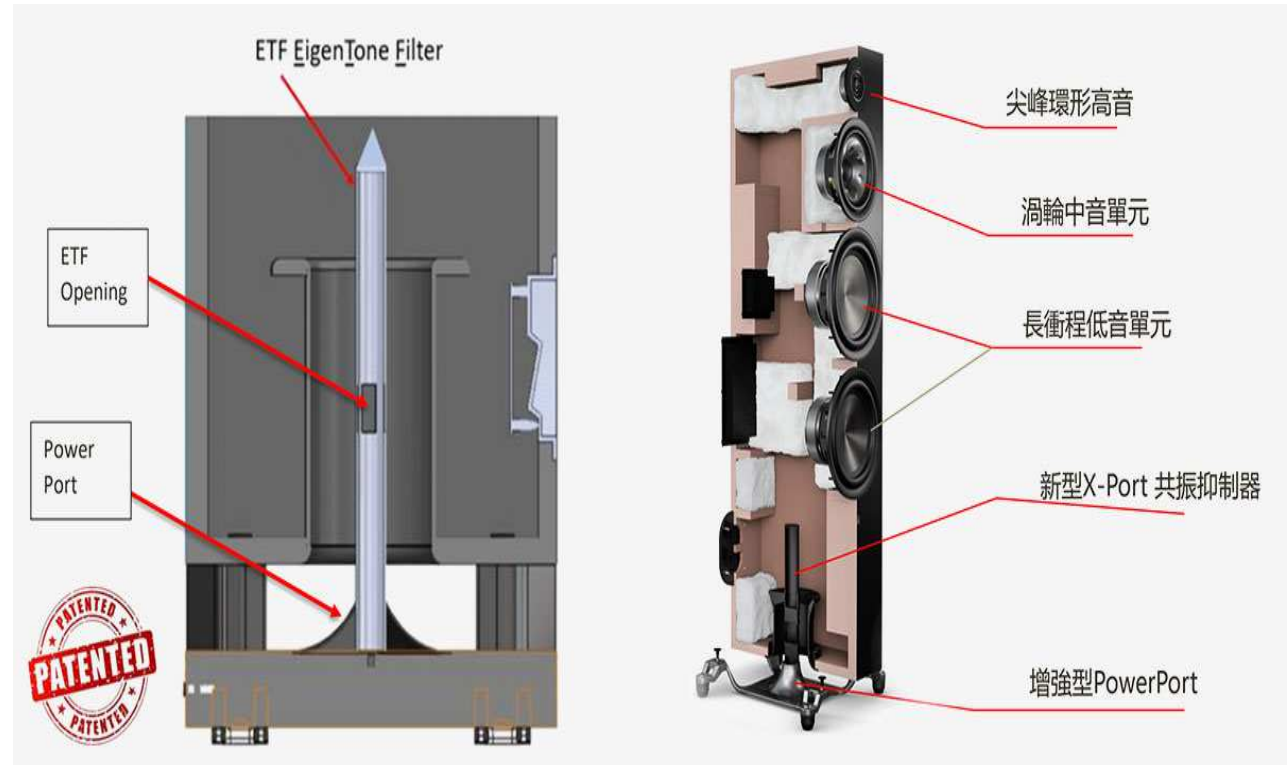

Patented X-Port technology, the hollow sound-absorbing tube is specially designed to absorb specific frequency resonance. With the original PowerPort, it can make the bass output cleaner and improve the low-frequency analysis.

# Mobile Bluetooth Speaker

- The latest mobile bluetooth speaker cooperated by Meilong and international car manufacturers
- It will be sold with Nissan's new Titan and Frontier trucks in 2022
- Between car and indoor and outdoor mobile audio



2022 Nissan TITAN® Accessory Tailgate Audio

# Mobile Bluetooth Speaker

*Rugged Portable Design*  
*WeatherProof*  
*Mounts Secure at car & home*



Nissan Tailgate Audio

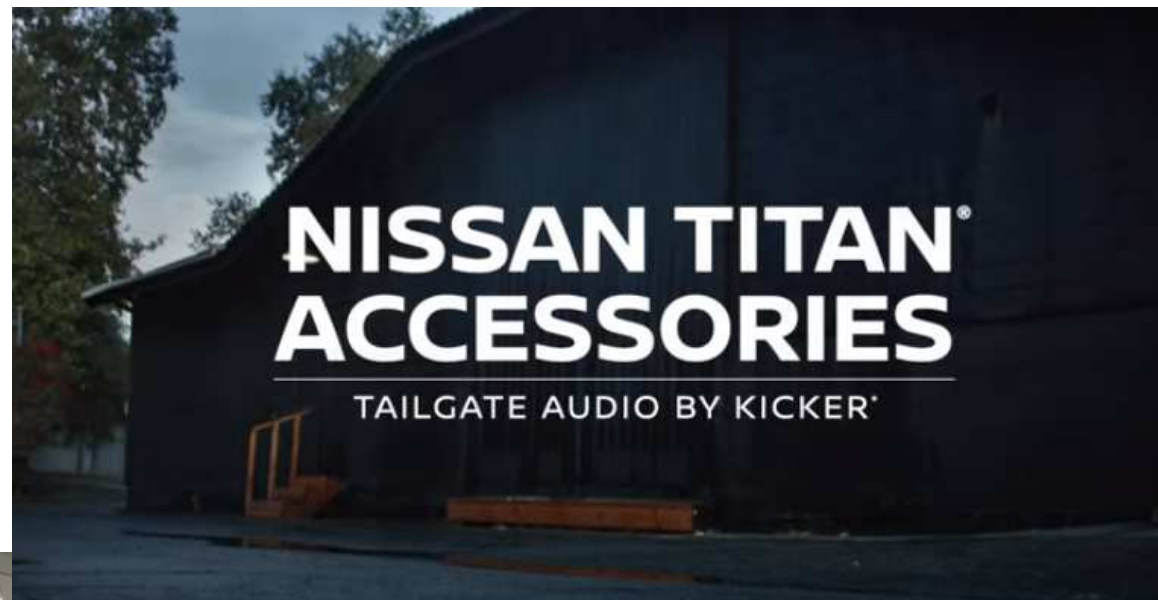

# Interactive device



Mom's Choice Award  
2021 Winner



Honoree  
Headphones & Personal Audio

Guided by Montessori education principles, the Jooki connects through WiFi and Bluetooth, helping parents empower their children to develop creativity and emotional awareness through their own access to a wide range of pre-selected songs, music, and stories.

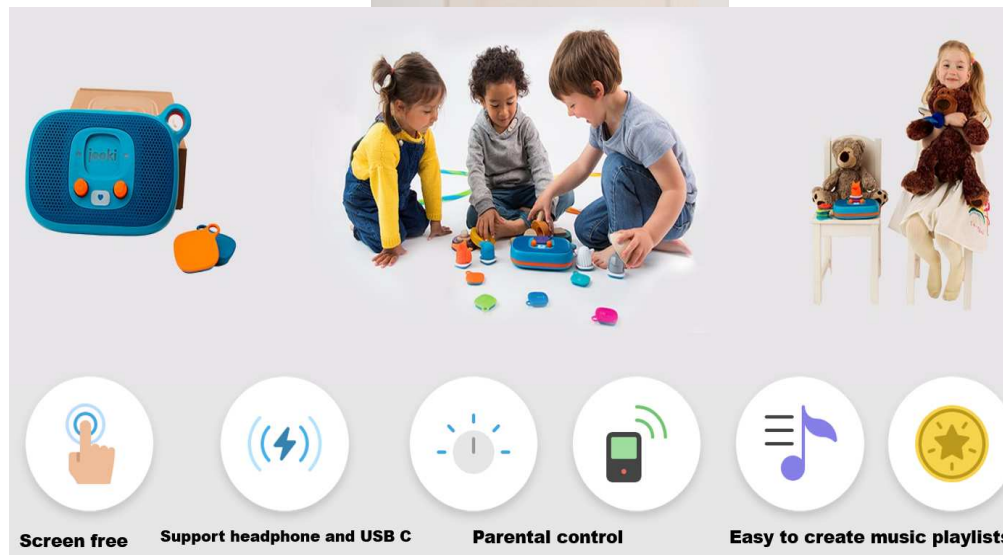

The screen-free speaker is the first kids' music/story player with Spotify music and audio book streaming. It features Jooki's patented NFC-enabled ToyTouch® Technology.

**Professional : market share 80% over professional installed sound**

# INSTALLED SOUND



## Movable Speaker

The World's Loudest Wireless Bluetooth Speaker





Quality • Innovation • Performance • Partnership

A background image showing two hands shaking in a firm grip, symbolizing partnership and agreement. The hands are rendered in a light blue, semi-transparent style against a darker blue background. On the left side, there are decorative, flowing blue and white wave-like patterns.

# Q & A