



景碩科技股份有限公司  
Kinsus Interconnect Technology Co.

2016 June



# IC 封裝技術

## IC Packaging Technology

# 電子產品構裝的各個層次

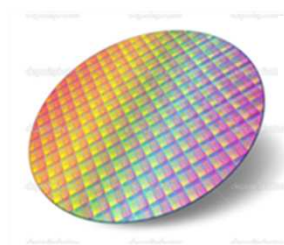

晶圓

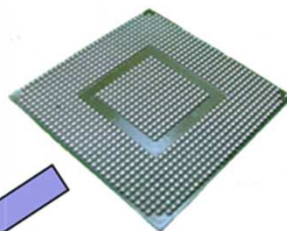

積體電路



印刷電路板

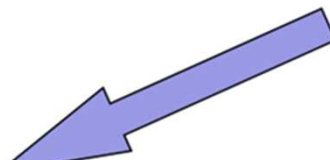
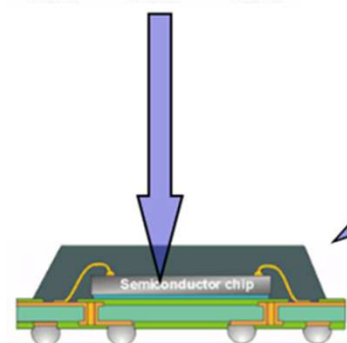

(軟板)

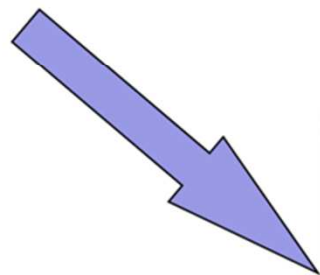

系統

# Levels of Assembly in Electronic Devices

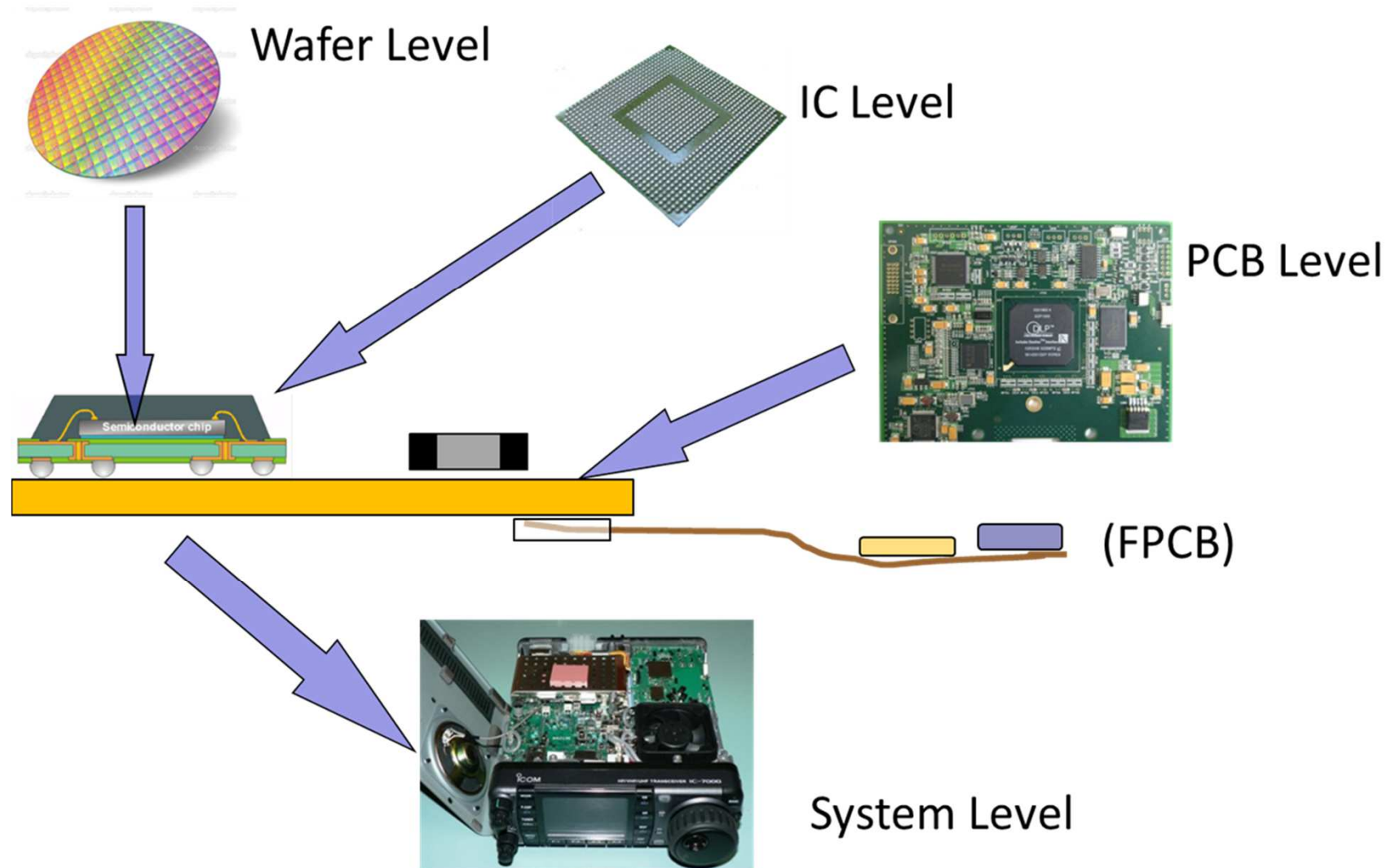

# 各種形式的 IC 封裝

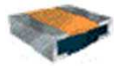

Chips



SOT/SOD



DPAK



SOJ

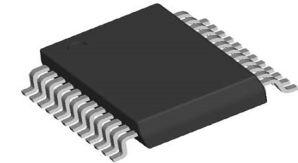

SOIC/SSOP/  
OSOP/TSSOP/  
MSOP/HSOP



TSOP

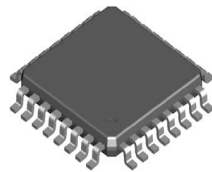

OFP/TOFP  
/LOFP

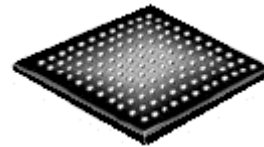

BGA/Flip-Chip  
/WLP



PLCC

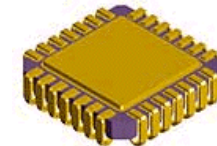

CLCC

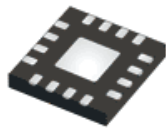

QFN

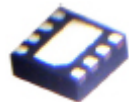

DFN



DIP



Axial



Radial

Through-hole

# Different types of IC packaging



Kinorus Tech.

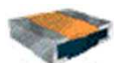

Chips



SOT/SOD



DPAK



SOJ

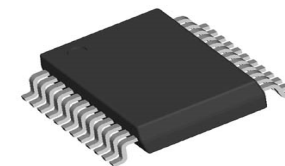

SOIC/SSOP/  
OSOP/TSSOP/  
MSOP/HSOP

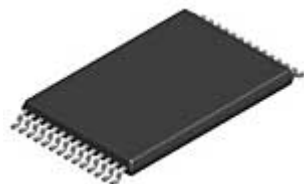

TSOP

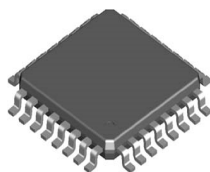

QFP/TOFP  
/LOFP

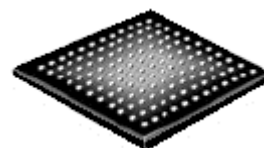

BGA/Flip-Chip  
/WLP

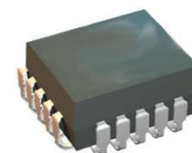

PLCC

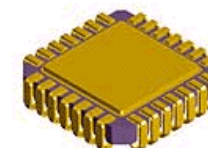

CLCC

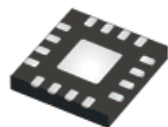

QFN

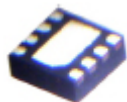

DFN

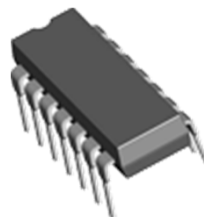

DIP



Axial



Radial

Through-hole

# 封裝技術走向

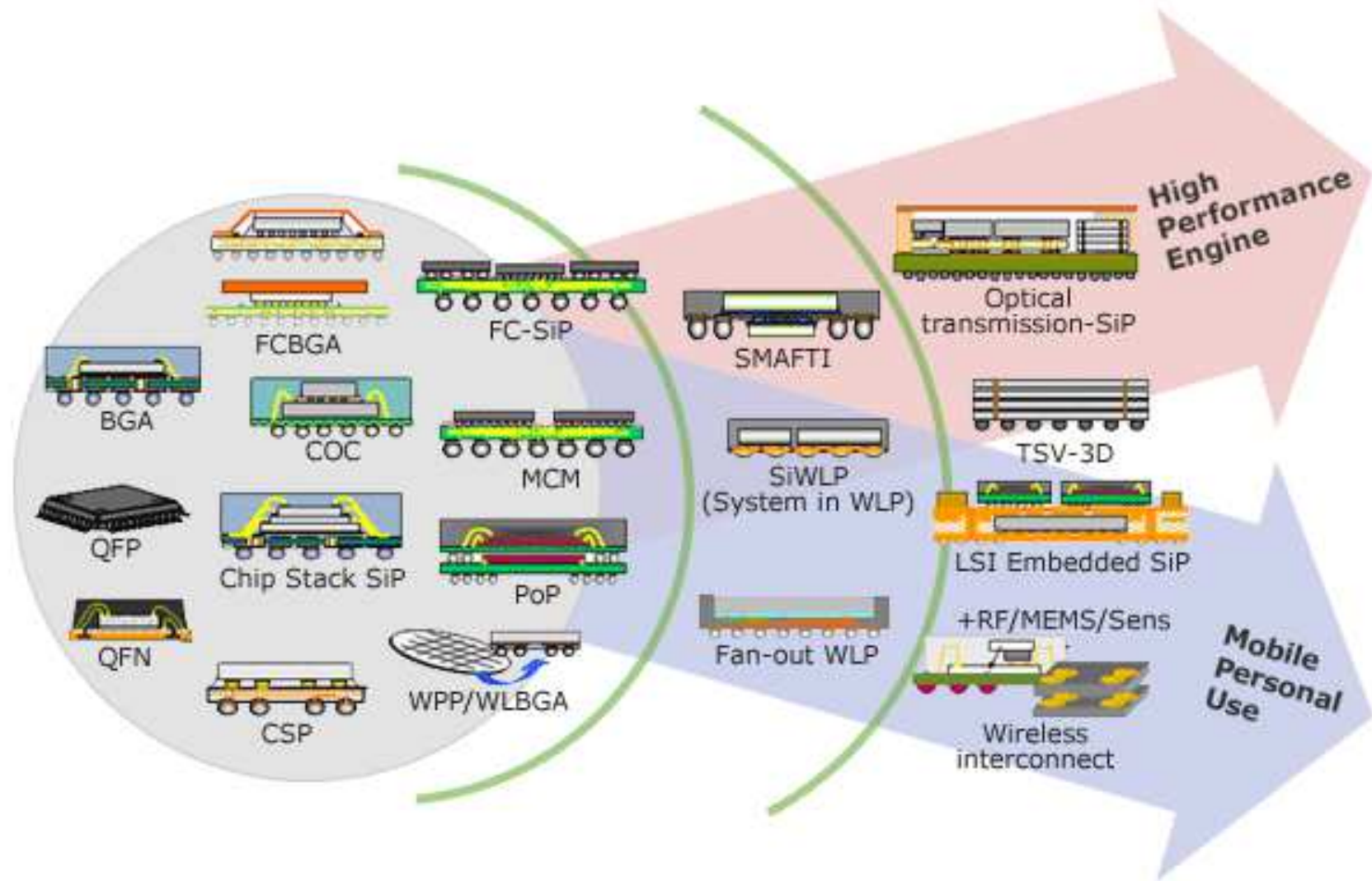

# Packaging Technology Roadmap



Kleins Tech.

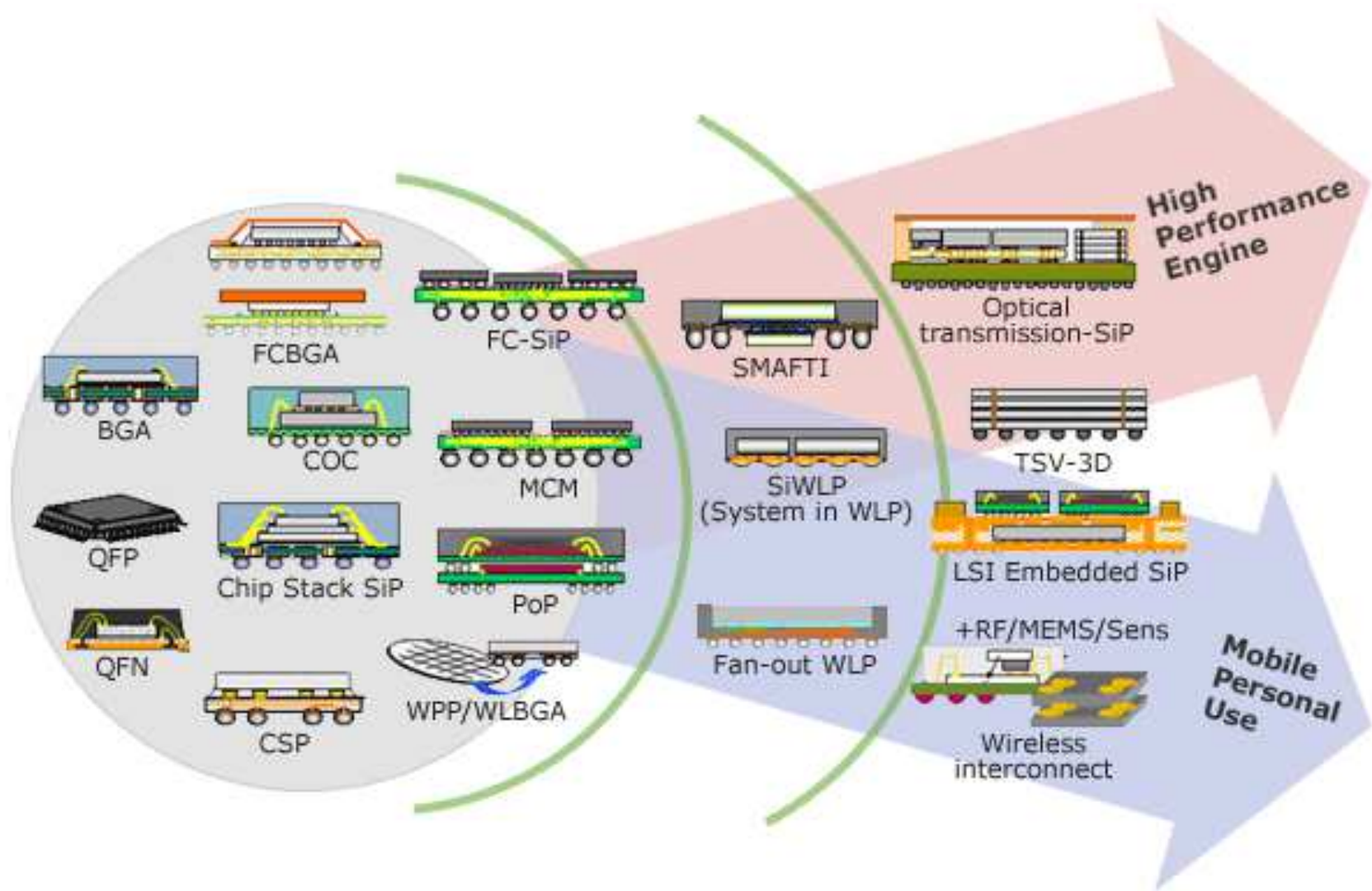

# IC 結構

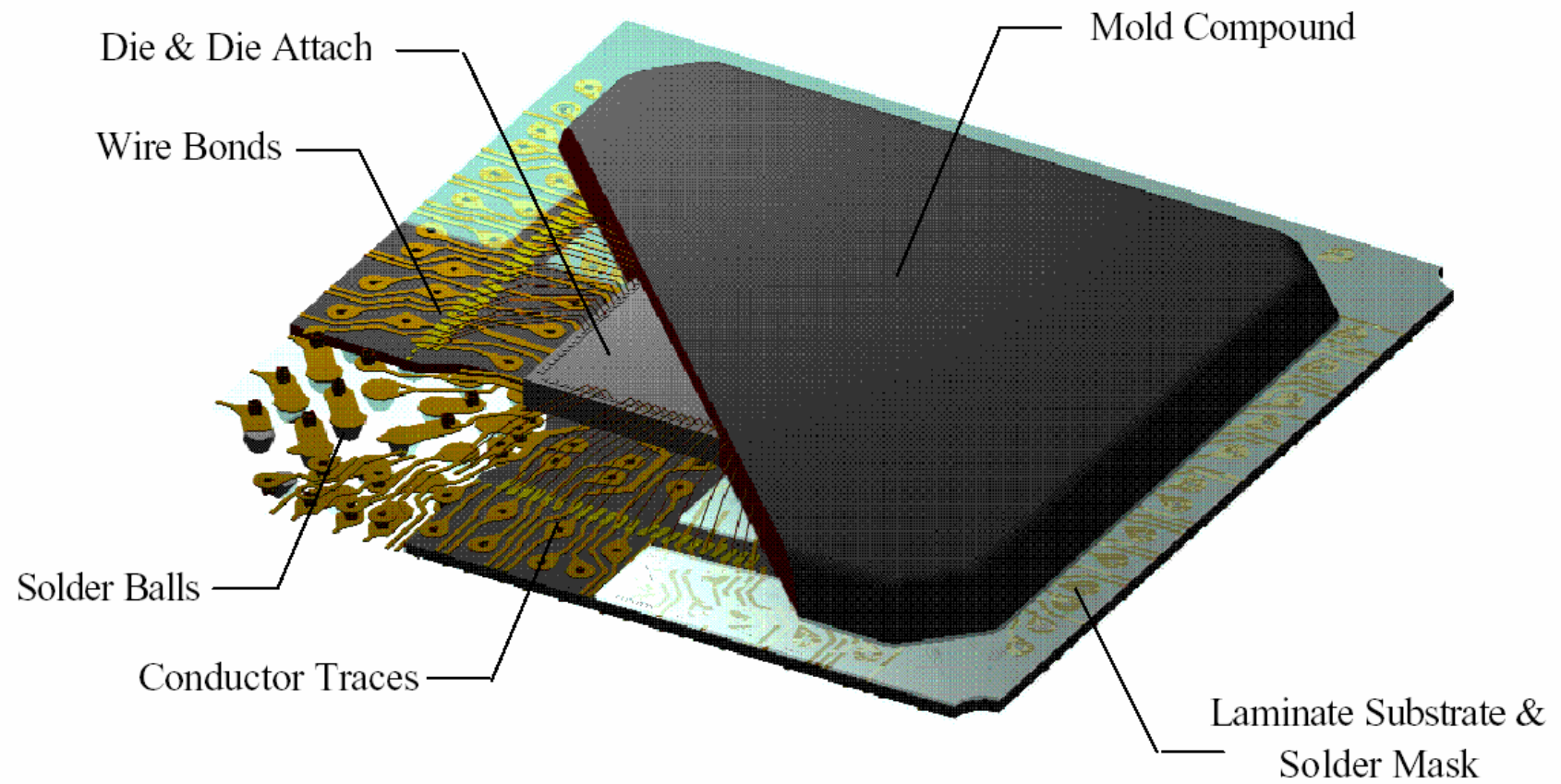

# What Substrate Makers do?

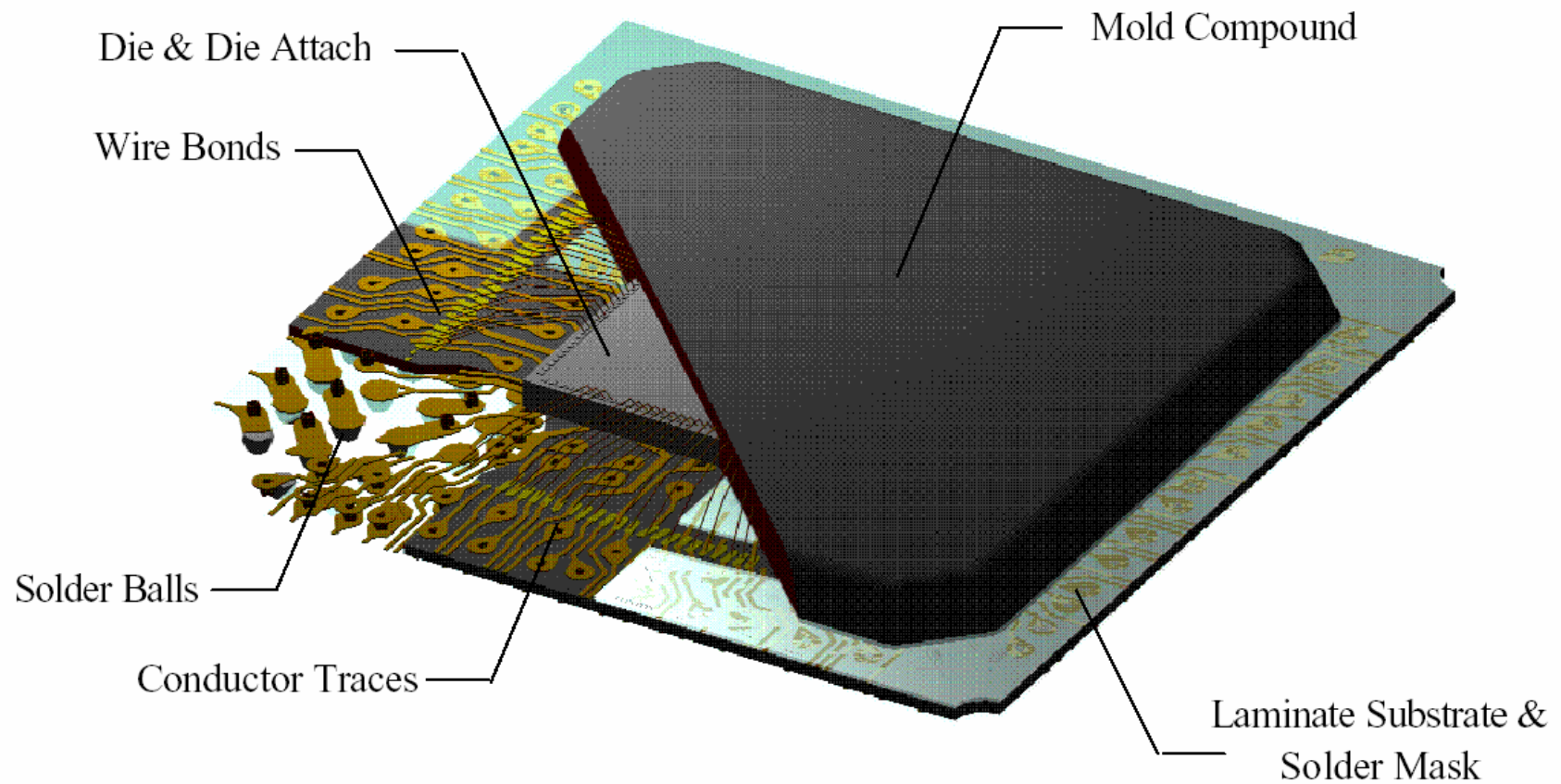

# IC 半導體上下游供應鏈關係

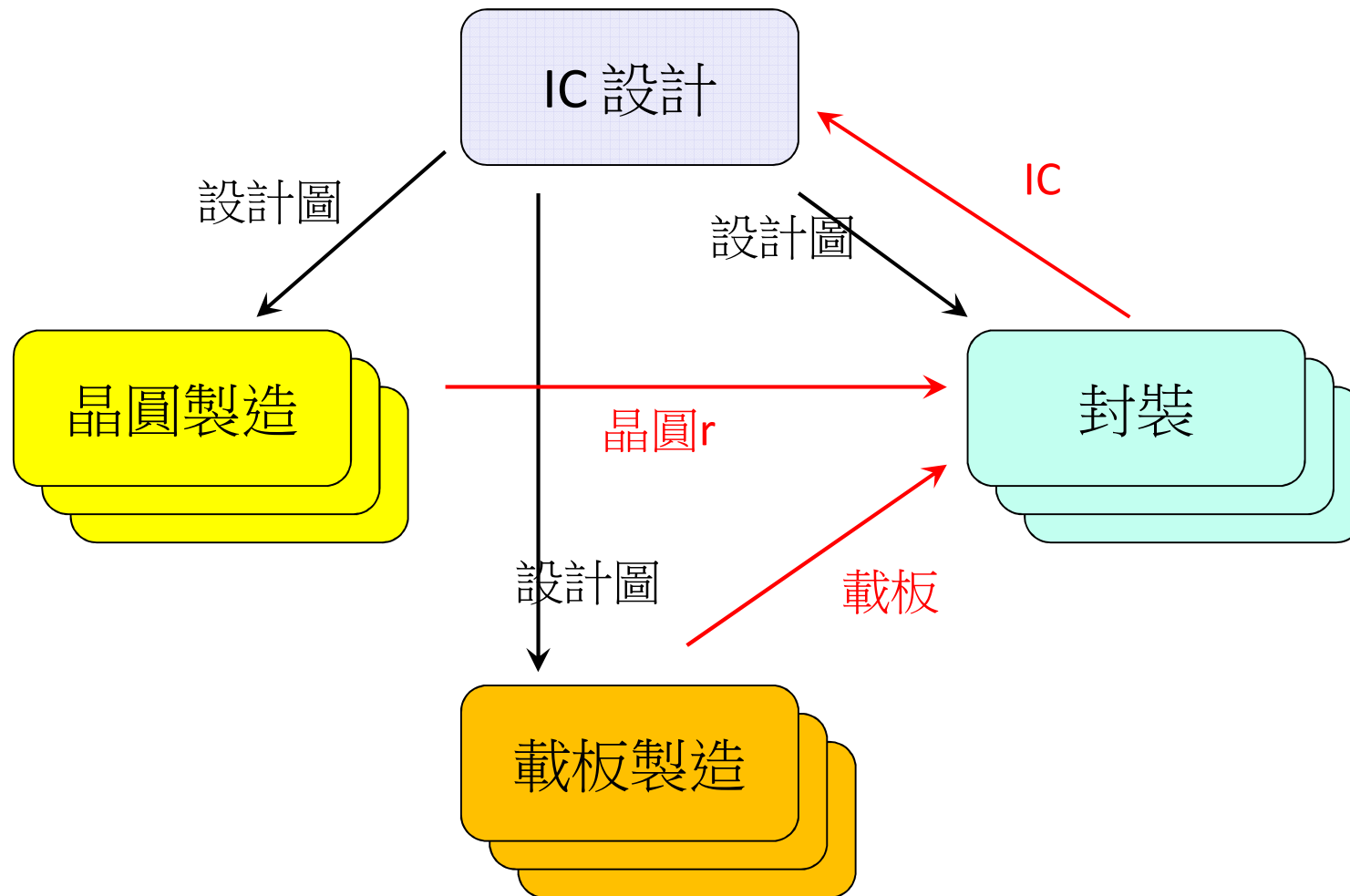

# IC Manufacturing Supply Chain

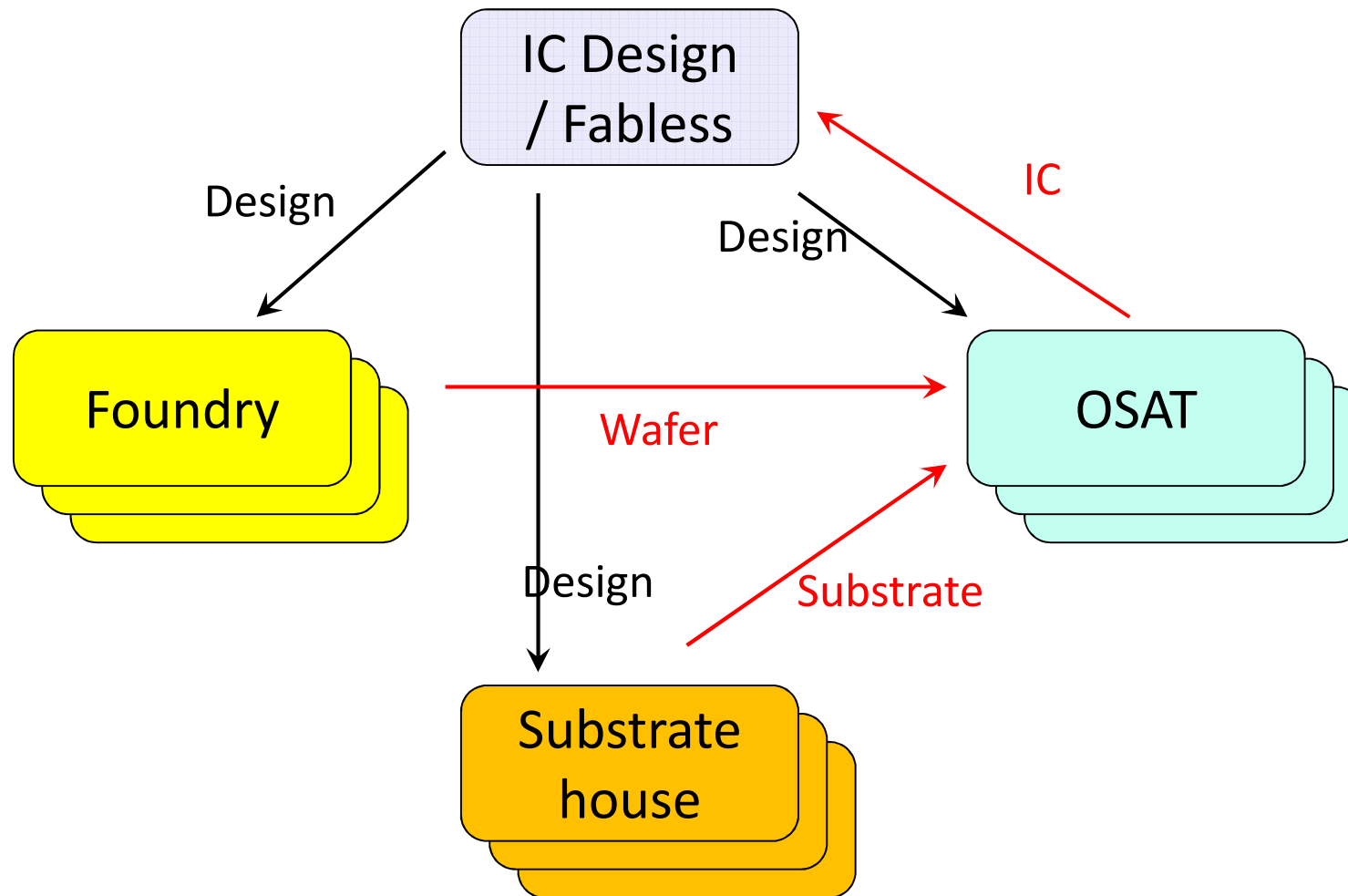



# About Kinsus

## 基本資料



- 成立 September 2000  
上市 November 2004
- 登記資本額 新台幣 44.6 億
- 員工數：3,600 (2016 五月)
- 廠區：
  - 總部
    - 石磊 / 新屋區
  - 硬質載板事業部
    - 一廠, 二廠
    - 五廠
  - 軟質載板事業部
    - 六廠
  - 美國子公司
    - Santa Clara / California
  - 中國子公司
    - 蘇州

## Basic Information



- Established in September 2000  
IPO in November 2004
- Capital : US\$ 154 Million (NT\$ 4.46 Billion)
- Headcounts : 3,600 as of May 2016
- Campus :

Headquarters	- Shih Lei / Sin Wu
Rigid Substrates BU	- Plant I, Plant II
	- Plant V
Flexible Substrate BU	- Plant VI
Kinsus USA	- Santa Clara / California
Kinsus China	- Suzhou

# 位置

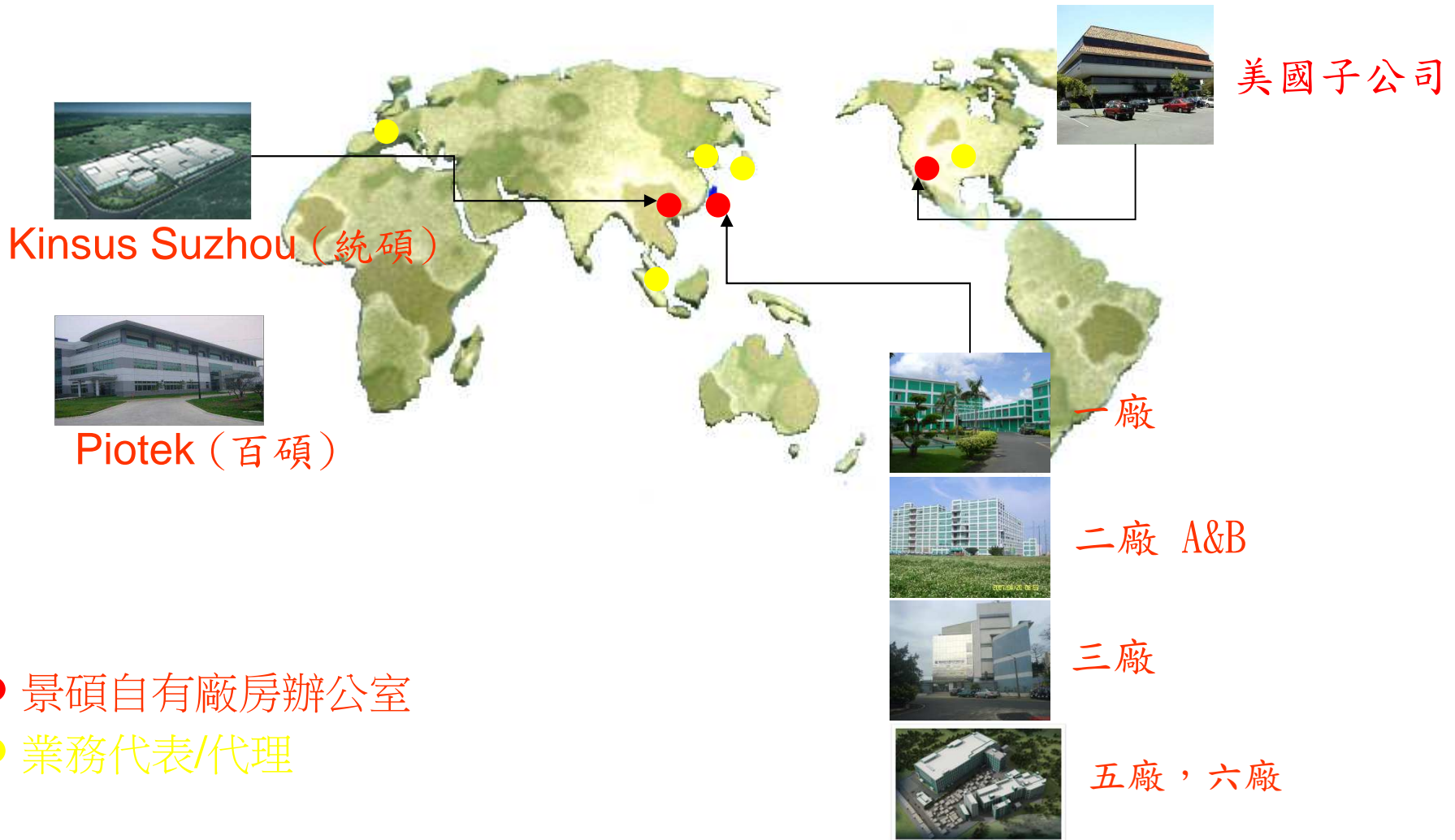

# Locations



- Kinsus owned facility
- Service representative

# 硬質載板產品



# Rigid Substrate Products



# 軟質載板產品

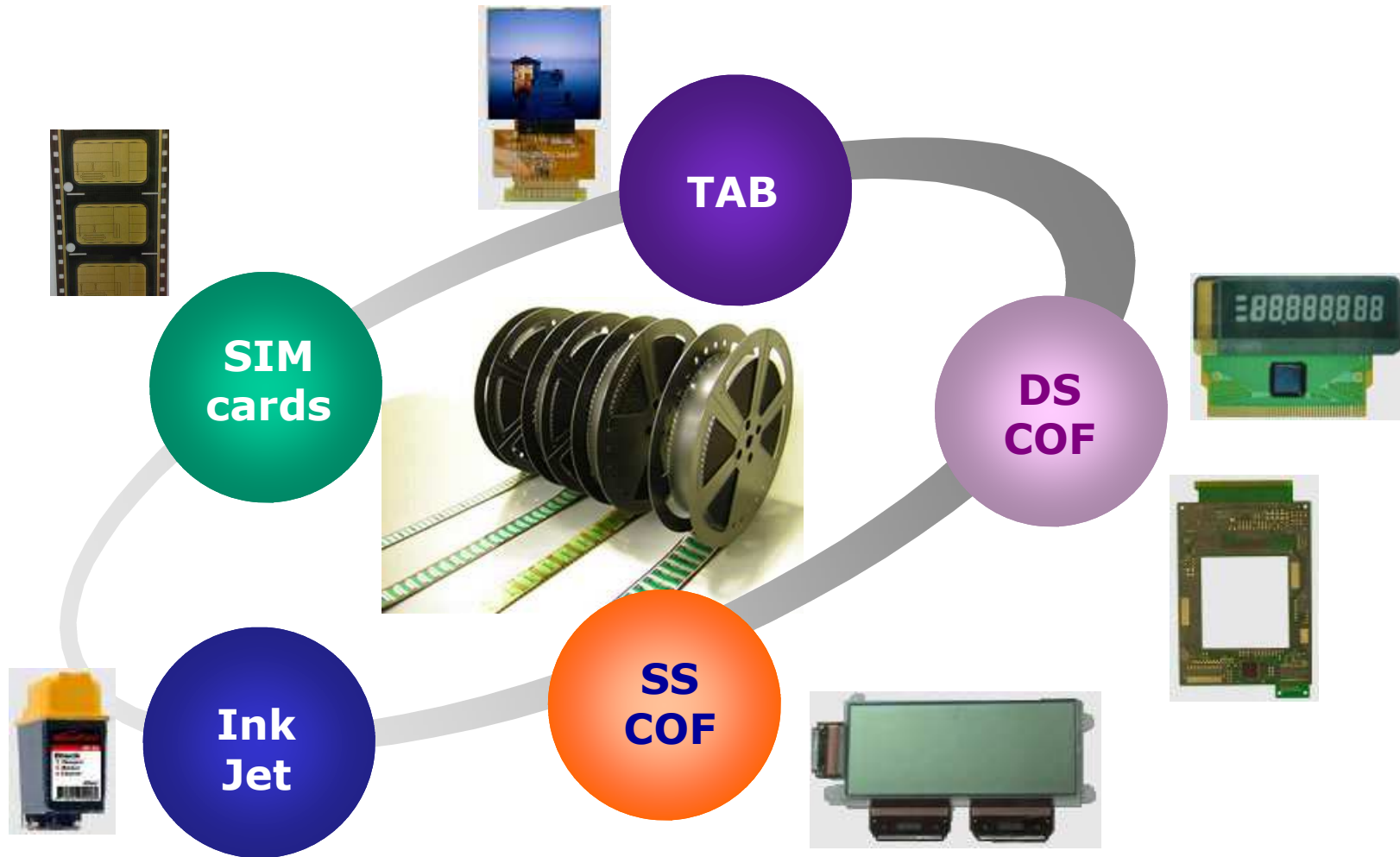

# Flexible Substrate Products

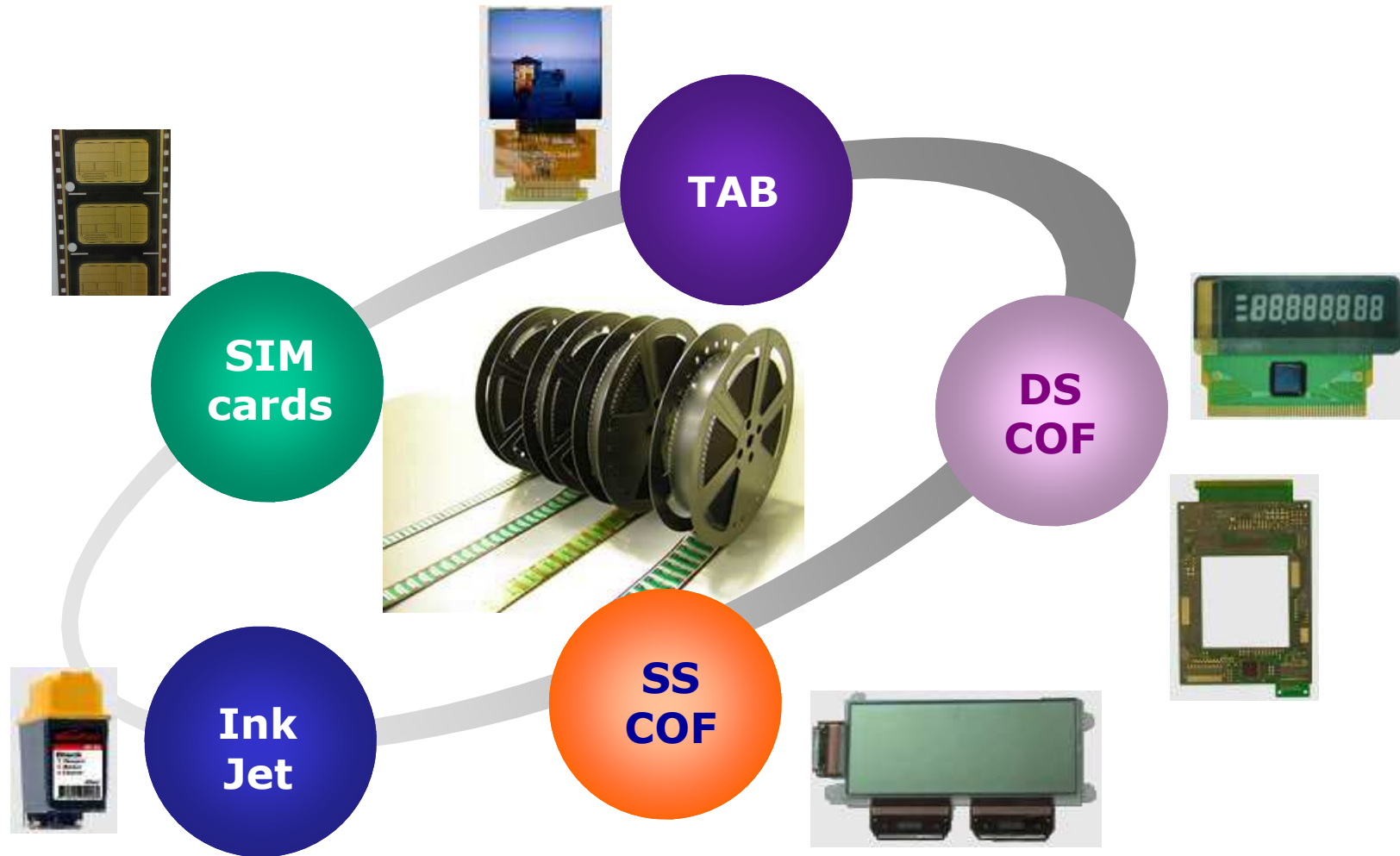

# 每月營業額



單位：新台幣百萬元

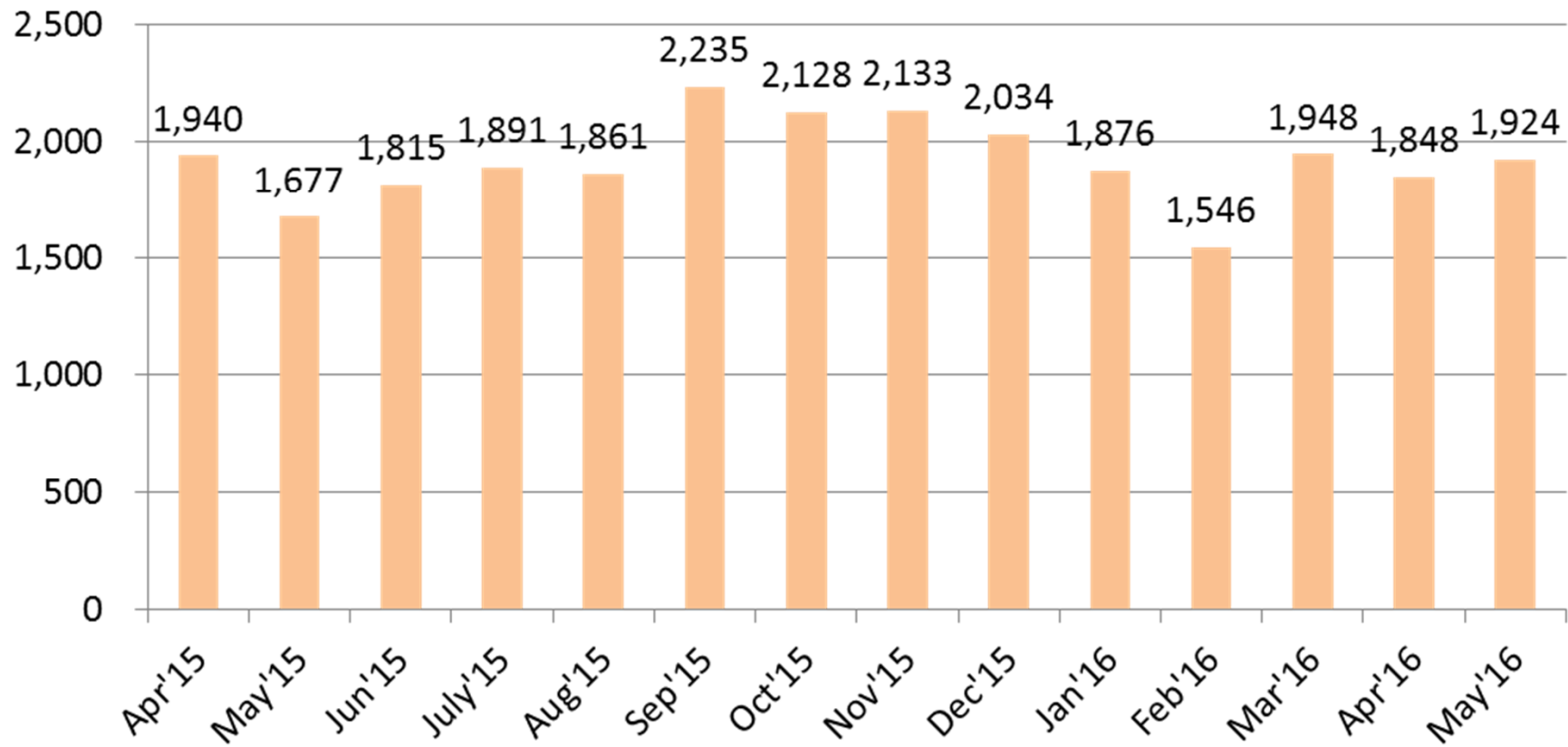

# Monthly Revenue



Unit : Million NT\$

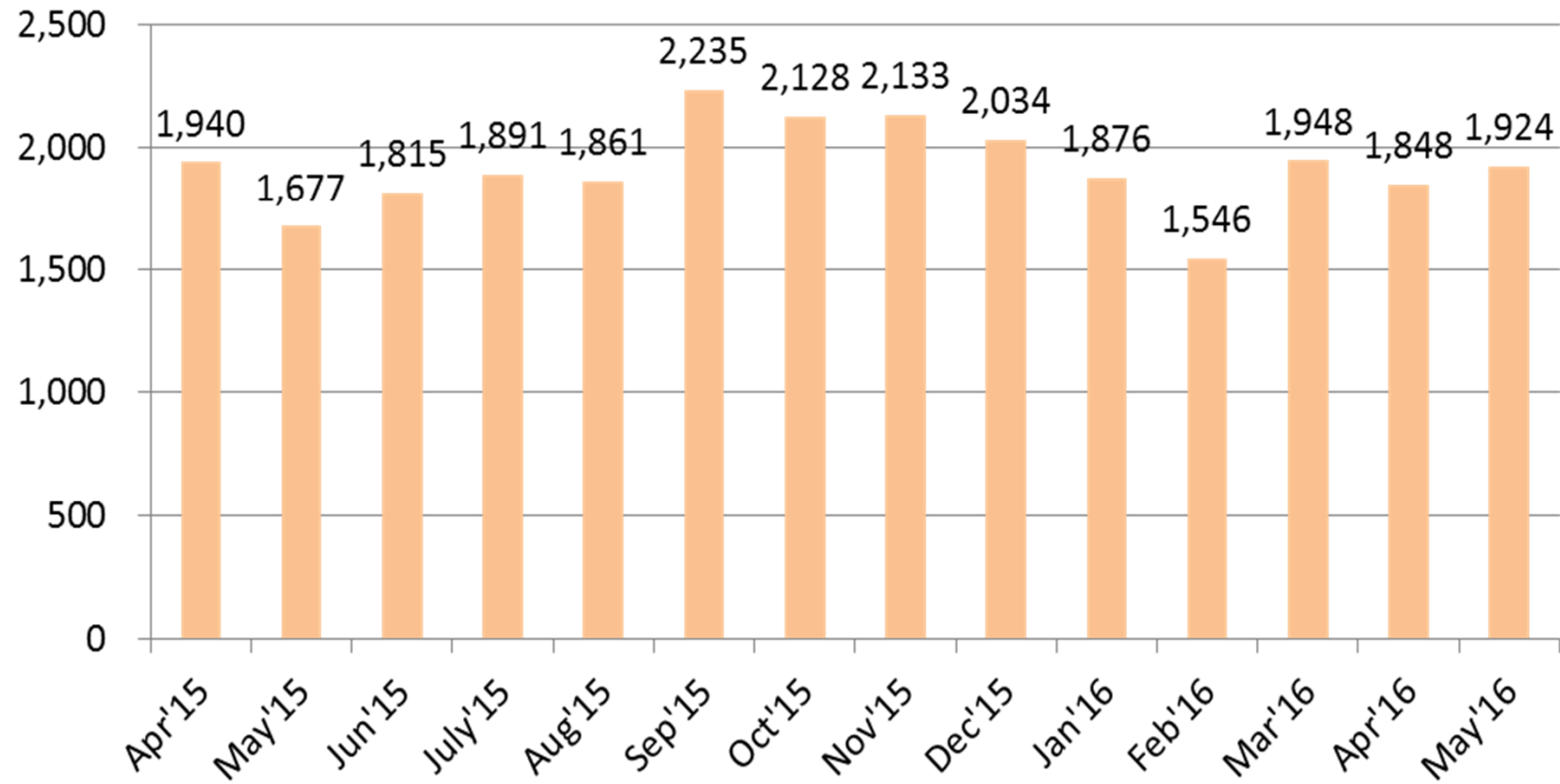

# 營業額分佈



Q1, 2016

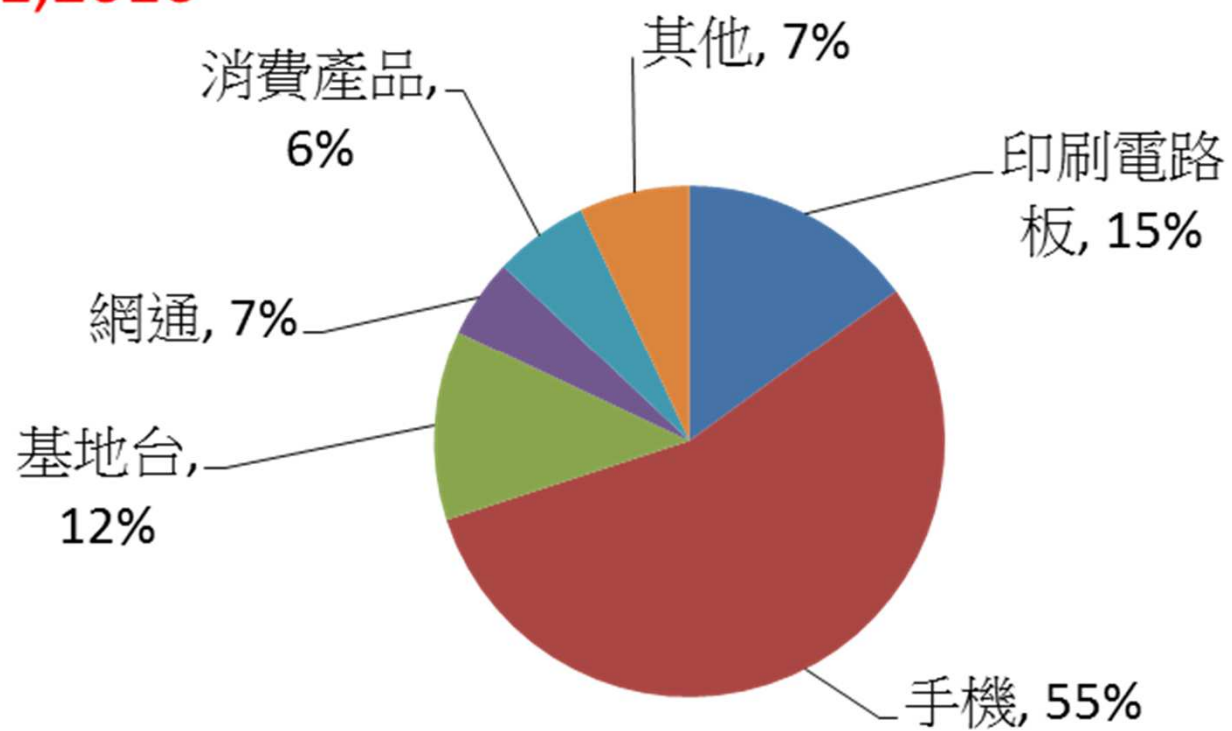

# Revenue - Application



Q1,2016

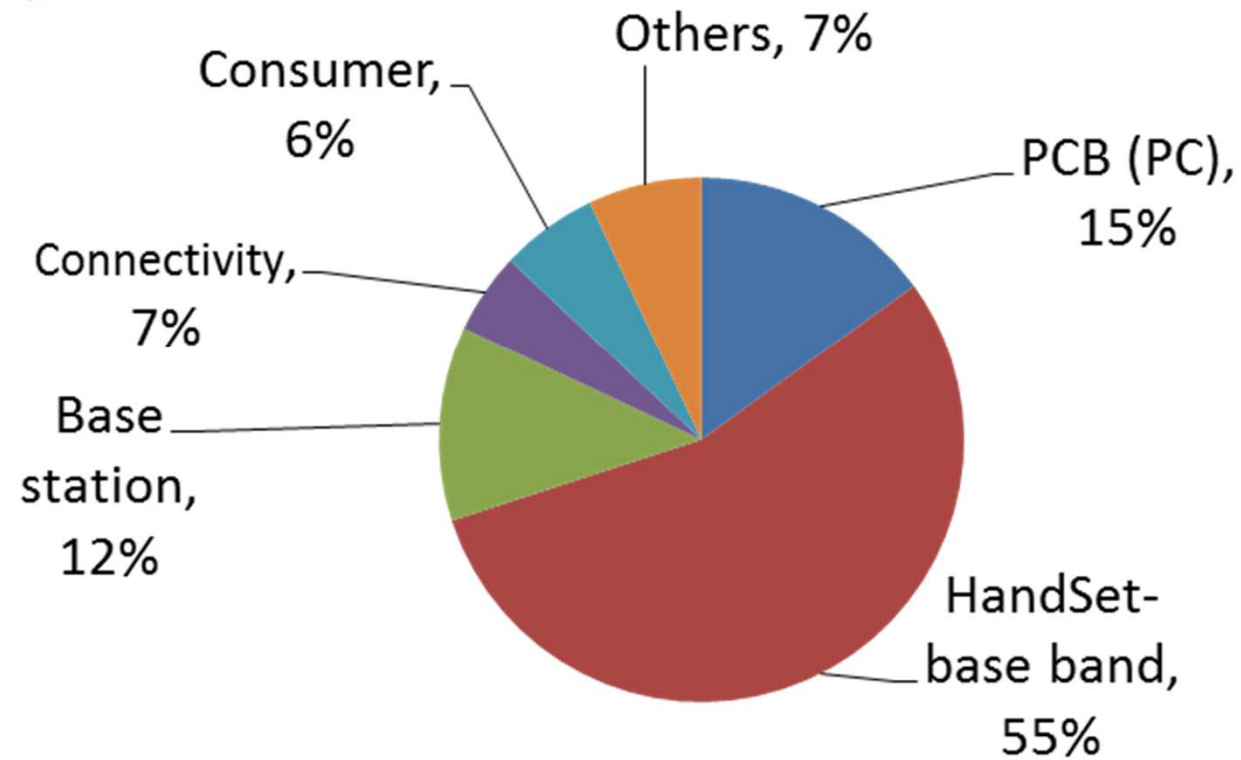



Thank You!